

LURA[®] COLLECTION

SPEAKMAN[®]



DESIGNED BY
CLODAGH

ABOUT THE DESIGNER

CLODAGH



Clodagh is an award-winning designer who passionately believes that good design can transform people's lives.

Clodagh embraces both ancient and cutting-edge methods to comfort not only the body but also the mind.

Clodagh Design projects have been recognized with numerous awards including Interior Design Magazine Top100 Interior Designers, Architectural Digest Top 100 Designers in the World and the Global Wellness Summit's 2018 Sustainability Leader.



LURA®

With Lura, we believe that less is more. Inspired by elements of both minimal and industrial design - each fixture in this collection features crisp lines and pronounced curves. The result is a classic, yet undeniably modern assortment that's ideal for both traditional and contemporary bathrooms alike.





WIDESPREAD

CROSS & PLATFORM LEVER HANDLES



CD521

- 1.2 GPM
- Pop-up drain with lift rod
- Cross handles
- WaterSense Certified



CD523

- 1.2 GPM
- Pop-up drain with lift-rod
- Lever handles
- WaterSense Certified

 POLISHED CHROME
CD521 / CD523

 MATTE BLACK
CD521MB / CD523MB

 BRUSHED BRONZE
CD521BBZ / CD523BBZ

WALL-MOUNTED CROSS HANDLES

Inspired by industrial charm, these cross handles offer a raw, undeniable vintage vibe delivering a truly unique look for your bathroom.

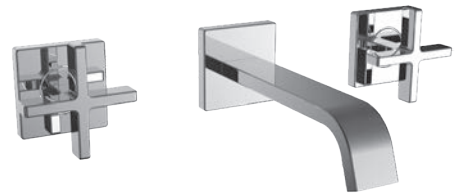

SB-2551
POLISHED CHROME

- 1.2 GPM
- Cross handles
- WaterSense Certified

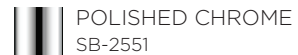

POLISHED CHROME
SB-2551



MATTE BLACK
SB-2551-MB

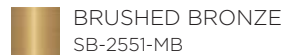

BRUSHED BRONZE
SB-2551-MB

WALL-MOUNTED LEVER HANDLES

Featuring a clean, simplified design - these blade handles deliver a truly minimalistic look and heightened sense of design.

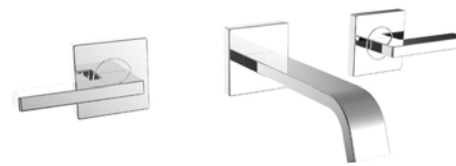

SB-2552
POLISHED CHROME

- 1.2 GPM
- Blade handles
- WaterSense Certified



POLISHED CHROME
SB-2552



MATTE BLACK
SB-2552-MB

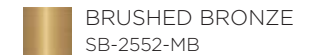

BRUSHED BRONZE
SB-2552-MB

WALL-MOUNTED PLATFORM LEVER HANDLES

Perfectly combining both styles together, the lever handles feature a geometric, circular body paired with a modern, level stem.



SB-2553
POLISHED CHROME

- 1.2 GPM
- Lever handles
- WaterSense Certified

 POLISHED CHROME
SB-2553

 MATTE BLACK
SB-2553-MB

 BRUSHED BRONZE
SB-2553-MB

TUB SPOUT

Features a minimal and sleek design for a truly modern look.



CDS1574
POLISHED CHROME

- Wall mounted tub spout measures 5-5/16" in length
- 1/2" NPTF female inlet
- Metal construction

 POLISHED CHROME
CDS1574

 MATTE BLACK
CDS1574-MB

 BRUSHED BRONZE
CDS1574-BBZ

CROSS HANDLE 5-HOLE ROMAN TUB FILLER

Industrial-inspired cross handle design married with a spout that creates a beautiful waterfall effect.



SB-2531

- 1.5 GPM hand shower
- 1/2" NPSM Male inlet (shower head)
- WaterSense Certified (hand shower only)

 POLISHED CHROME
SB-2531

 MATTE BLACK
SB-2531-MB

 BRUSHED BRONZE
SB-2531-BBZ

PLATFORM LEVER HANDLE 5-HOLE ROMAN TUB FILLER

Features a minimalistic spout paired with sleek lever handles. The details carry into the all-metal hand shower wand and water diverter, for the ultimate in style and substance.



SB-2533

- 1.5 GPM hand shower
- 1/2" NPSM Male inlet (shower head)
- WaterSense Certified (hand shower only)

 POLISHED CHROME
SB-2533

 MATTE BLACK
SB-2533-MB

 BRUSHED BRONZE
SB-2533-BBZ

CROSS HANDLE FREE STANDING TUB FILLER



SB-2534

- 1.5 GPM hand shower
- 1-1/2" NPT female inlet (faucet)
- 1/2" NPSM Male inlet (shower head)
- Push button diverter
- WaterSense Certified (hand shower only)

 POLISHED CHROME
SB-2534 / SB-2536

 MATTE BLACK
SB-2534-MB / SB-2536-MB

 BRUSHED BRONZE
SB-2534-BBZ / SB-2536-BBZ

PLATFORM LEVER HANDLE FREE STANDING TUB FILLER



SB-2536

- 1.5 GPM hand shower
- 1-1/2" NPT female inlet (faucet)
- 1/2" NPSM Male inlet (shower head)
- Push button diverter
- WaterSense Certified (hand shower only)





SHOWER VALVE

CROSS & PLATFORM LEVER HANDLE



CPT-25401
CPT-25001 (NON-DIVERTER)

- Metal cross handles
- Metal trim plate
- Includes mounting plate and hardware
- For use with Speakman® thermostatic and pressure balance valves



CPT-25403
CPT-25003 (NON-DIVERTER)

- Metal lever handles
- Metal trim plate
- Includes mounting plate and hardware
- For use with Speakman® thermostatic and pressure balance valves



POLISHED CHROME
CPT-25401
CPT-25001 (Non-Diverter)

CPT-25403
CPT-25003 (Non-Diverter)



MATTE BLACK
CPT-25401-MB
CPT-25001-MB (Non-Diverter)

CPT-25403-MB
CPT-25003-MB (Non-Diverter)



BRUSHED BRONZE
CPT-25401-BBZ
CPT-25001-BBZ (Non-Diverter)

CPT-25403-BBZ
CPT-25003-BBZ (Non-Diverter)

15IN. SQUARE RAIN SHOWER

CEILING MOUNT FLANGE

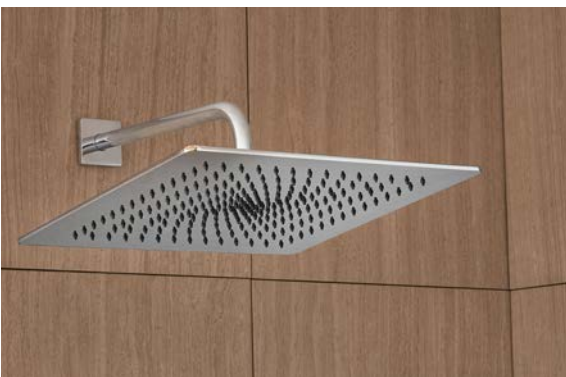

S-2764 (SHOWER HEAD ONLY)

- 210 rubber spray outlets, 1 spray pattern
- 1/2" - 14 NPTF female inlet
- Metal Construction

**Available in 2.5, 2.0 and 1.75 GPM flow rates*

VS-127

- For flush ceiling mounted shower head
- For use with S-2764
- Stainless Steel & Aluminum Construction

 Note: Brushed Nickel, Polished Nickel, Satin Brass, and Oil Rubbed Bronze available as special order only.

 POLISHED CHROME
S-2764 / VS-127

 MATTE BLACK
S-2764-MB / VS-127-MB

 BRUSHED BRONZE
S-2764-BBZ / VS-127-BBZ

WALL MOUNTED SHOWER ARM & FLANGE

CEILING-MOUNTED SHOWER ARM



S-2572

- 16in. shower arm and flange
- 1/2" - 14 NPTF female inlet
- Metal Construction

 POLISHED CHROME
S-2572 / CDS2582

 MATTE BLACK
S-2572-MB / CDS2582-MB



CDS2582 - POLISHED CHROME

- Arm measures 6" in length
- Brass construction
- 1/2" - 14 NPTM connections
- Ceiling-mounted installation

 BRUSHED BRONZE
S-2572-BBZ / CDS2582-BBZ



TRANSFER VALVE

CROSS & PLATFORM
LEVER HANDLE

Features a sleek, thin, valve trim, and a cross handle with flexibility to transition between two shower fixtures.

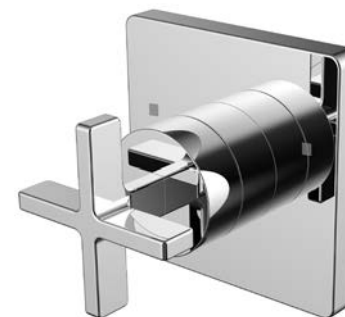

CPT-1121 - POLISHED CHROME

- Transfers between 2 functions
- Metal trim and cross handle
- Includes mounting plate and hardware
- For use with Speakman® transfer valve



CPT-1123 - POLISHED CHROME

- Transfers between 2 functions
- Metal trim and lever handle
- Includes mounting plate and hardware

 POLISHED CHROME
CPT-1121/ CPT-1123

 MATTE BLACK
CPT-1121-MB/ CPT-1123-MB

 BRUSHED BRONZE
CPT-1121-BBZ/ CPT-1123-BBZ

SHOWER ARM & FLANGE

Carries the same signature details found throughout the Lura collection:
clean, sleek and stylized lines.



CDS2501

- 7-3/8" in length
- 1/2" - 14 NPTM connections
- Wall mounted installation
- Stainless Steel Construction

 POLISHED CHROME
CDS2501

 MATTE BLACK
CDS2501-MB

 BRUSHED BRONZE
CDS2501-BBZ

SLIDE BAR

Clean, minimalist style slide bar that includes an easy adjust push button
slider with hand shower holder.



SA-2502

- 26" slideable length
- Pivoting hand shower holder
- Steel construction

 POLISHED CHROME
SA-2502

 MATTE BLACK
SA-2502-MB

 BRUSHED BRONZE
SA-2502-BBZ

SUPPLY ELL & HAND SHOWER HOLDER

Beautiful integrated bracket that houses your Hand Shower Wand and Hose.



VS-159

- Integrated hand shower bracket
- 1/2" - 14 NPT inlet
- 1/2" - 14 NPSM outlet
- Metal Construction

 POLISHED CHROME
VS-159

 MATTE BLACK
VS-159-MB

 BRUSHED BRONZE
VS-159-BBZ

ROBE HOOK

Features a minimal and sleek design for a truly modern look.



SA-2506

- Metal Construction
- Mounting Hardware Included

 POLISHED CHROME
SA-2506

 MATTE BLACK
SA-2506-MB

 BRUSHED BRONZE
SA-2506-BBZ

TOWEL BAR 18" & 24"

Features the sleek and serene lines of the collection and marries beauty with function.



SA-2507-18
18" POLISHED CHROME

- Metal Construction
- Mounting Hardware Included

SA-2507
24" POLISHED CHROME

- Metal Construction
- Mounting Hardware Included

 POLISHED CHROME
SA-2507
SA-2507-18

 MATTE BLACK
SA-2507-MB
SA-2507-18-MB

 BRUSHED BRONZE
SA-2507-BBZ
SA-2507-18-BBZ

HAND TOWEL HOLDER

A perfectly sized and paired addition to our towel bars to maintain that minimal clean bathroom look.



SA-2504

- Metal Construction
- Mounting Hardware Included

 POLISHED CHROME
SA-2504

 MATTE BLACK
SA-2504-MB

 BRUSHED BRONZE
SA-2504-BBZ

RESERVE PAPER HOLDER

Brings a clean, minimalist look to the bath for stylish sensibility.



SA-2508

- Metal Construction
- Mounting Hardware Included

 POLISHED CHROME
SA-2508

 MATTE BLACK
SA-2508-MB

 BRUSHED BRONZE
SA-2508-BBZ

PAPER HOLDER

Sleek and deep design to accommodate most sizes of paper.



SA-2505

- Metal Construction
- Mounting Hardware Included

 POLISHED CHROME
SA-2505

 MATTE BLACK
SA-2505-MB

 BRUSHED BRONZE
SA-2505-BBZ

PAPER HOLDER SHELF

A modern and thoughtful addition to any well appointed bathroom.



SA-251 (SHELF ONLY)

- Holder for paper or towel bars
- Metal Construction
- Mounting Hardware Included
- Metal Construction

 POLISHED CHROME
SA-251

 MATTE BLACK
SA-251-MB

 BRUSHED BRONZE
SA-251-BBZ

Life-Enhancing Minimalism™

The belief that good design can transform people's lives.

- CLODAGH



SPEAKMAN[®]

SPEAKMAN.COM | 800.537.2107



LURA-Q12020

PPG Professional
PLUMBING GROUP